

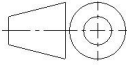



Änd. 2	Änderungsdatum 05.01.2022	Änderung durch Bettina Neuwirth		Allgemeintoleranz ISO 2768 - mK	Artikelnummer 53103030	Format A4
 www.schilling-fn.de SCHILLING Kran- und Hebertechnik GmbH Ernst-Zimmermann-Straße 9-11 88045 Friedrichshafen Deutschland			Zeichnungsnummer 53103030-000		Masse 123,01 kg	Maßstab 1 : 20
			Titel, zusätzlicher Titel H-Traverse		Werkstoff	

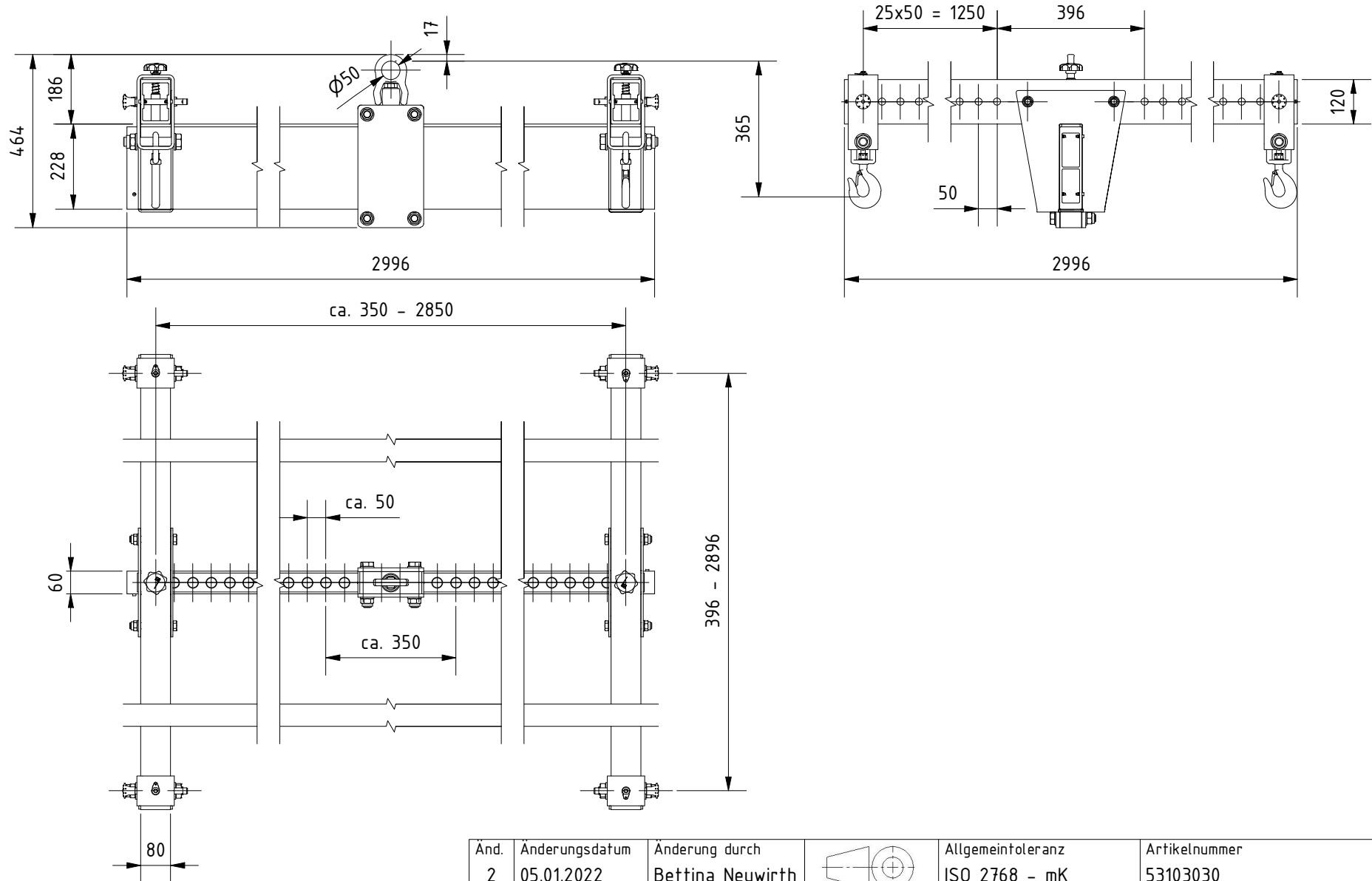
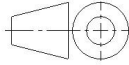

Änd. 2	Änderungsdatum 05.01.2022	Änderung durch Bettina Neuwirth		Allgemeintoleranz ISO 2768 - mK	Artikelnummer 53103030	Format A4
 www.schilling-fn.de ■ SCHILLING Kran- und Hebetechnik GmbH ■ Ernst-Zimmermann-Straße 9-11 ■ 88045 Friedrichshafen ■ Deutschland				Zeichnungsnummer 53103030-000		Maßstab 1 : 15
				Titel, zusätzlicher Titel H-Traverse		Werkstoff
				Erstellungsdatum 17.12.2020	Erstellt durch Bettina Neuwirth	Blatt 2/2